

P1: M-005B  
 P2: M-Y087A  
       M-087A  
 P3: M-087B

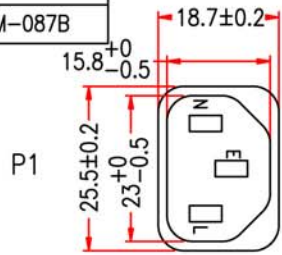

P1

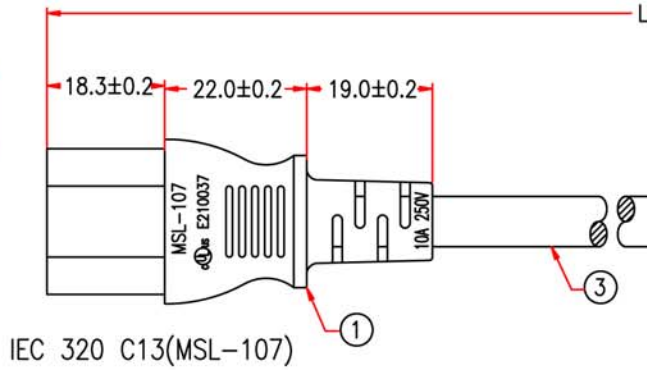

IEC 320 C13(MSL-107)

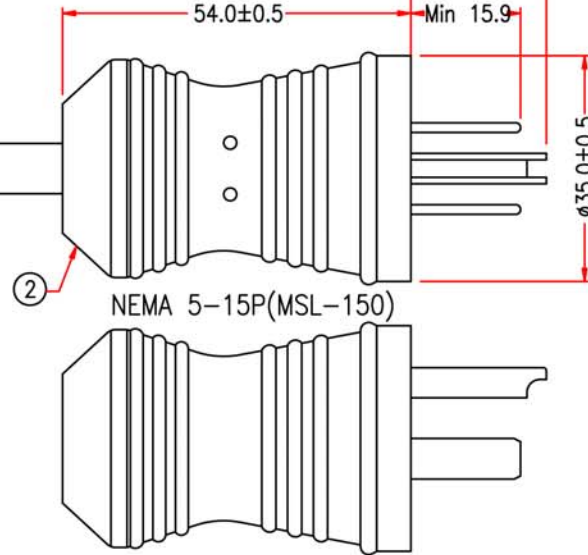

NEMA 5-15P(MSL-150)

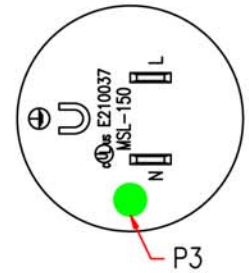

P2

P3

P1,P2: cULus E210037

PACKING A: <3M

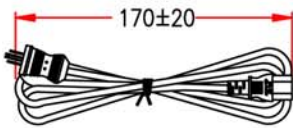

| ITEM NO.         | LENGTH(L) | LENGTH(X) |
|------------------|-----------|-----------|
| P7HG-18AWG-BK-03 | 915mm     | 895mm     |
| P7HG-18AWG-BK-06 | 1830mm    | 1810mm    |
| P7HG-18AWG-BK-10 | 3048mm    | 3030mm    |
| P7HG-18AWG-BK-15 | 4572mm    | 4550mm    |
| P7HG-18AWG-BK-25 | 7620mm    | 7600mm    |

PACKING B: =6FT

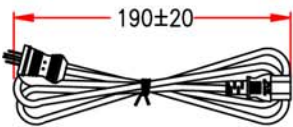

PACKING C: >=3M

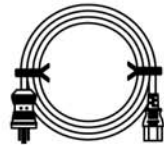

CABLE MARKING:

(UL) SJT 3/C 18AWG(0.824MM<sup>2</sup>) VW-1 105°C 300V E204978  
 CSA SJT 3/C 0.824MM<sup>2</sup>(18AWG) FT2 105°C 300V 204790 MSL

|                        |    |       |    |
|------------------------|----|-------|----|
| 107150B2F18B(FP327-01) |    |       |    |
|                        | P1 |       | P2 |
| BLACK                  | L  | _____ | L  |
| WHITE                  | N  | _____ | N  |
| GREEN                  | E  | _____ | E  |

NOTE: All relevant materials are complied with RoHS directive .  
 THE CABLE MARKING IS CONCAVE LETTERING MOULD

|     |                                                                         |                |     |       |          |
|-----|-------------------------------------------------------------------------|----------------|-----|-------|----------|
| 3   | UL SJT 18AWG x 3C, OD 7.8mm, JACKET BLACK, DRAWING No. EPSVT011803C-142 | H5TC20-0304K09 | Xmm | M304  |          |
| 2   | MOLDED PVC 80P, COLOR GREEN                                             | H1BP01-0304N07 |     | M304  |          |
|     | MOLDED PVC 45P, COLOR BALCK (外模)                                        | H1BF01-0304K09 |     | M304  |          |
|     | MOLDED PVC 35P, COLOR BALCK (内模)                                        | H1BC02-0304K09 |     | M304  |          |
|     | RIVETING CLAW (脚爪)                                                      | A1RT06-1220    | 1   | M1220 |          |
|     | TERMINAL: 98478BL-1                                                     | A1RQ99-0257    | 1   | M257  |          |
| 1   | TERMINAL: 98693BL-1                                                     | A1RT05-0257    | 2   | M257  |          |
|     | MOLDED PVC 35P, COLOR BLACK                                             | H1BC02-0304K09 |     | M304  |          |
|     | BRACKET: CP-R445A-BS                                                    | A1QC61-0767    | 1   | M767  |          |
|     | TERMINAL: 2*4mm, 98744BS-0/A                                            | A1QB24-0257    | 3   | M257  |          |
| No. | 木子                                                                      | DESCRIPTION    |     | Q'TY  | Supplier |

|          |            |
|----------|------------|
| APPROVED | 2021.03.17 |
| CHECKED  | 陳瑞雯        |
| DESIGNER | JIANG      |
| DRAWING  | ZHU        |
| DATE     | 17/MAR/21  |

**SF Cable**  
 1-888-275-8755

Cable Length Unless Other Spec.  
 Tolerances:  
 0 ~200mm ±10mm  
 201~1000mm ±20mm  
 1001 ~1500mm ±25mm  
 1501~2100mm ±30mm  
 2100mm↑ ±40mm