

P1: M-004

P2: M-028A

Customer No: No:1

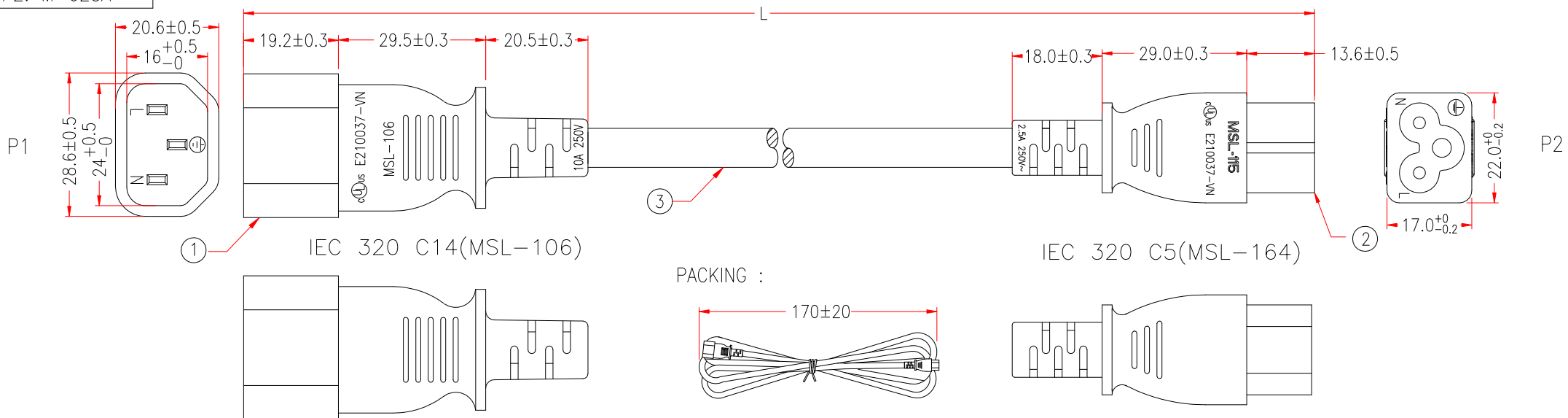

PACKING: 1pcs IN A POLYBAG

PACKING: 10pcs IN A POLYBAG

MARKING: (UL) SJT 3/C 18AWG(0.824MM<sup>2</sup>) VW-1 105°C 300V E204978 C(UL) SJT 3/C 0.824MM<sup>2</sup>(18AWG) FT2 105°C 300V E204978 MSL-VN-

P1,P2: cULus E210037-VN

NOTE: All relevant materials are complied with RoHS directive . THE CABLE MARKING IS CONCAVE LETTERING MOULD

3	UL SJT 18AWG x 3C, OD 7.8mm, JACKET BLACK, DRAWING No. EPSVT011803C-142	H5TC20-0304K09	L-40mm	M304	
2	MOLDED PVC 35P, COLOR BLACK	H1BC02-0304K09		M304	
	TERMINAL WITH BRACKET:M97723A-3PB	A1QC84-0257K09	1	M257	
1	MOLDED PVC 35P, COLOR BLACK	H1BC02-0304K09		M304	
	BRACKET: YS-014, COLOR BLACK	A1QC10-0767K09	1	M767	
	TERMINAL: 2x4mm 98672BS-1	A1QB07-0257	3	M257	
No.	DESCRIPTION			Q'TY	Supplier

APPROVED			Cable Length Unless Other Spec. Tolerances: 0 ~200mm ±10mm 201~1000mm ±20mm 1001 ~1500mm ±25mm 1501~2100mm ±30mm 2100mm↑ ±40mm
CHECKED	HU		
DESIGNER	XJW		
DRAWING	WEI		
DATE	02/APR/24		

DATE	02/APR/24	ITEM NO.	SF-3214-XXB-18	UNIT:mm		
------	-----------	----------	----------------	---------	--	--

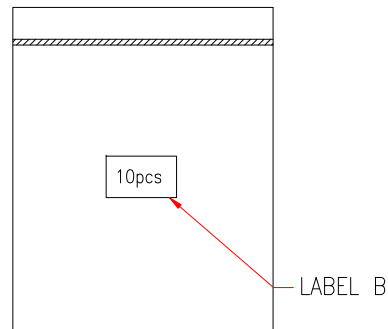
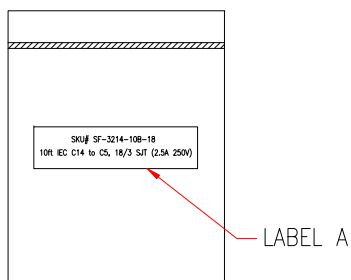

106164B2F18E(FP450-04)			
	P1		P2
BLACK	L	_____	L
WHITE	N	_____	N
GREEN	E	_____	E

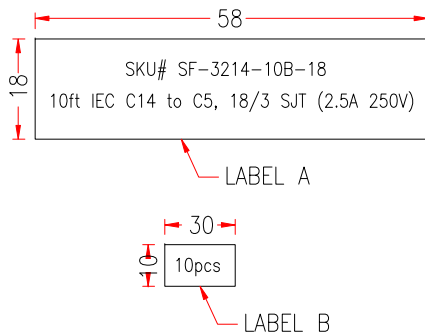

CHECKED

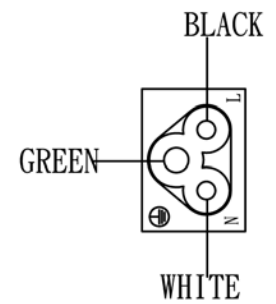
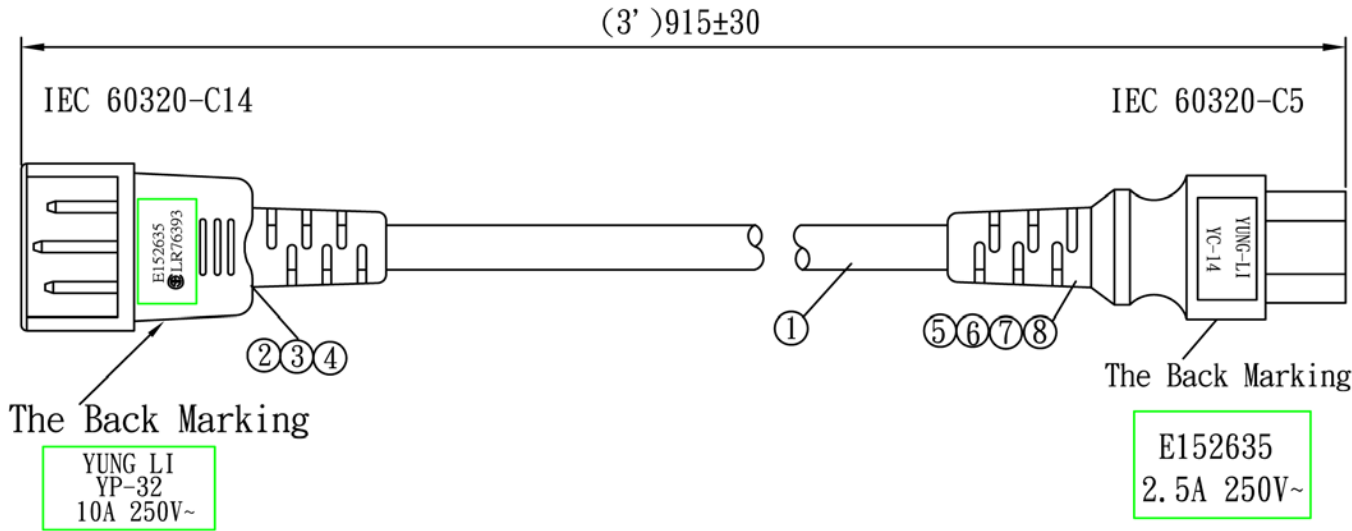
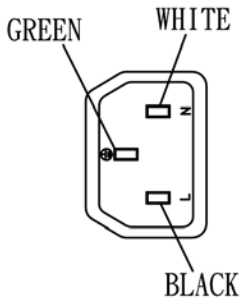

Packing: Bulk Pack.

XX = FT  
 03 = 3 ft  
 06 = 6 ft  
 10 = 10 ft

NO.	SPECIFICATION	Q' TY	REMARK
1	SJT 18/3C 105 °C BLACK	1PC	
2	YP-32 PVC PLASTIC:35P BLACK	15g/PC	
3	TER:98672BS-1	3PCS	
4	INNER BODY: 2X4	1PC	
5	YC-14 PVC PLASTIC:35P BLACK	18g/PC	
6	TER:98732	1PC	
7	TER:98714	2PCS	
8	YC-14 H. S. G BLACK	1PC	

Tolerance >0±0.30 >1.0±0.50 >10.0±1.0 >20.0±2.0 Angle: ±1°	Approved		Date		<b>SFCable.com</b> 1-888-275-8755			
	Checked		Date					
	Drawn		Date		Customer			
	Cat. No.	UL YP-32/YC-14			P/N.	SF-3214-XXB-18		
	Drawing No.		Rev.	B	Material	P. V. C	Unit	mm
				Scale				